



TOYOTA COROLLA (E21)  
saloon, estate incl. hybrid

01/19-

Cat. No. T/A71

E20

E20\*55R01/07\*005822\*00

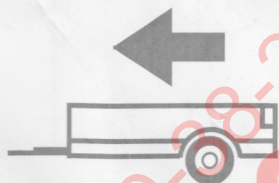

1980kg



80kg

D=9,41kN

D (kN) =

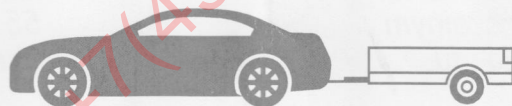

MAX kg

x

MAX kg

x 0,00981

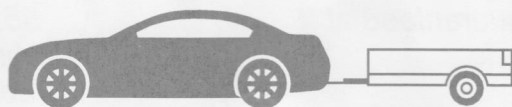

MAX kg

+

MAX kg



IMIOLA HAK-POL

96-111 KOWIESY, CHOJNATA 23A, POLAND

Tel. + 48 46 831 73 31, fax +48 831 74 29

e-mail: office@imiola.pl, www.imiola.pl

PRZEKRÓJ A-A

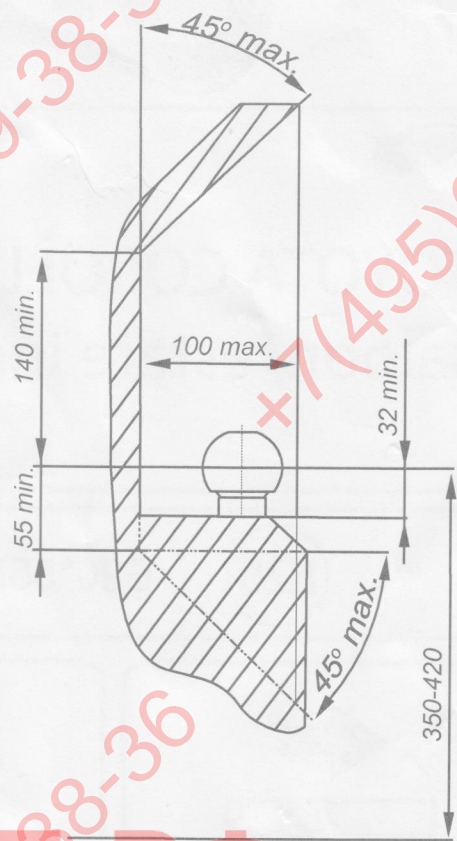
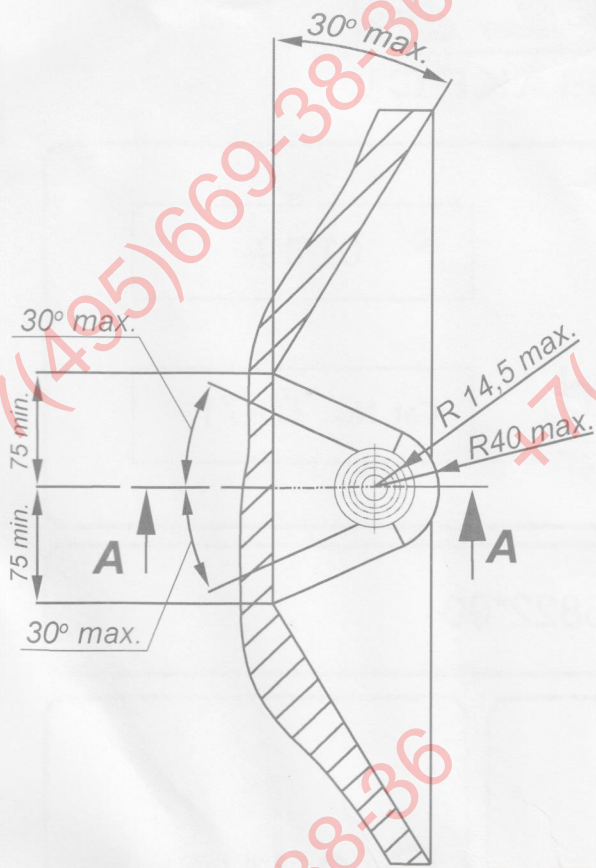

ФАРКОП.РФ

**PL** Należy zagwarantować przestrzeń swobodną według załącznika VII, rysunek 25a/b Regulaminu EKG ONZ 55.01 przy dopuszczalnym ciężarze całkowitym pojazdu.

**F** L'espace libre doit être garanti conformément à l'annexe VII, illustration de la réglementation 55.01 CE pour un poids total en charge autorisé du véhicule.

**GB** The clearance specified in appendix VII, diagram 25a/b of Regulation No. 55.01 UN EU must be guaranteed at laden weight of the vehicle.

**D** Der Freiraum nach Anhang VII, Abbildung 25a/b der Vorschriften 55.01 EG ist zu gew 25a/bahrleisten bei zulässigem Gesamtgewicht des Fahrzeuges.

Moment skręcający dla śrub i nakrętek (8.8)  
Torgue settings for nuts and bolts (8.8)

M8	25Nm
M10	55Nm
M12	85Nm
M14	135Nm
M16	195Nm



Šruba M12x35-8.8 ; Bolt  
 Podkl. sprež. 12.2 ; Spring Washer  
 Podkl. okr. Ø36xØ13x3 ;  
 Plain Washer

Nakretna M12 ; Nut  
 Podkl. sprež. 12.2 ; Spring Washer  
 Podkl. okr. 13 ; Plain Washer

Šruba M12x35-8.8 ;  
 Bolt

Šruba M12x22-8.8 ; Bolt  
 Podkl. sprež. 12.2 ; Spring Washer

Šruba M12x22-8.8 ; Bolt

Šruba M12x35-8.8 ; Bolt  
 Podkl. sprež. 12.2 ; Spring Washer  
 Podkl. okr. Ø36xØ13x3 ;  
 Plain Washer







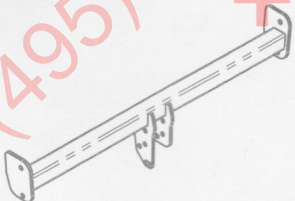
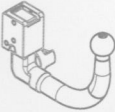

Šruba M12x35-8.8 ; Bolt

Šruba M12x22-8.8 ; Bolt

Šruba M12x22-8.8 ; Bolt  
 Podkl. sprež. 12.2 ; Spring Washer

**ФАРКОТ.РФ**

**+7 (495) 669-38-36**

	A	x1		M12x35	8
	B	x1		M12x22	6
	C	x1		M12	4
	D	x1		Ø36xØ13x3	4
	E	x1		13	4
	F	x2		12.2	10
	G	x1			

+7(495)669-38-36

+7(495)669-38-36

+7(495)669-38-36

Nakrętka M12; Nut  
Podkł. spręż. 12,2; Spring Washer  
Podkł. okr. 13; Plain Washer

Śruba M12x35-8.8; Bolt  
Podkł. spręż. 12,2; Spring Washer  
Podkł. okr. Ø36x Ø13x 3;  
Plain Washer

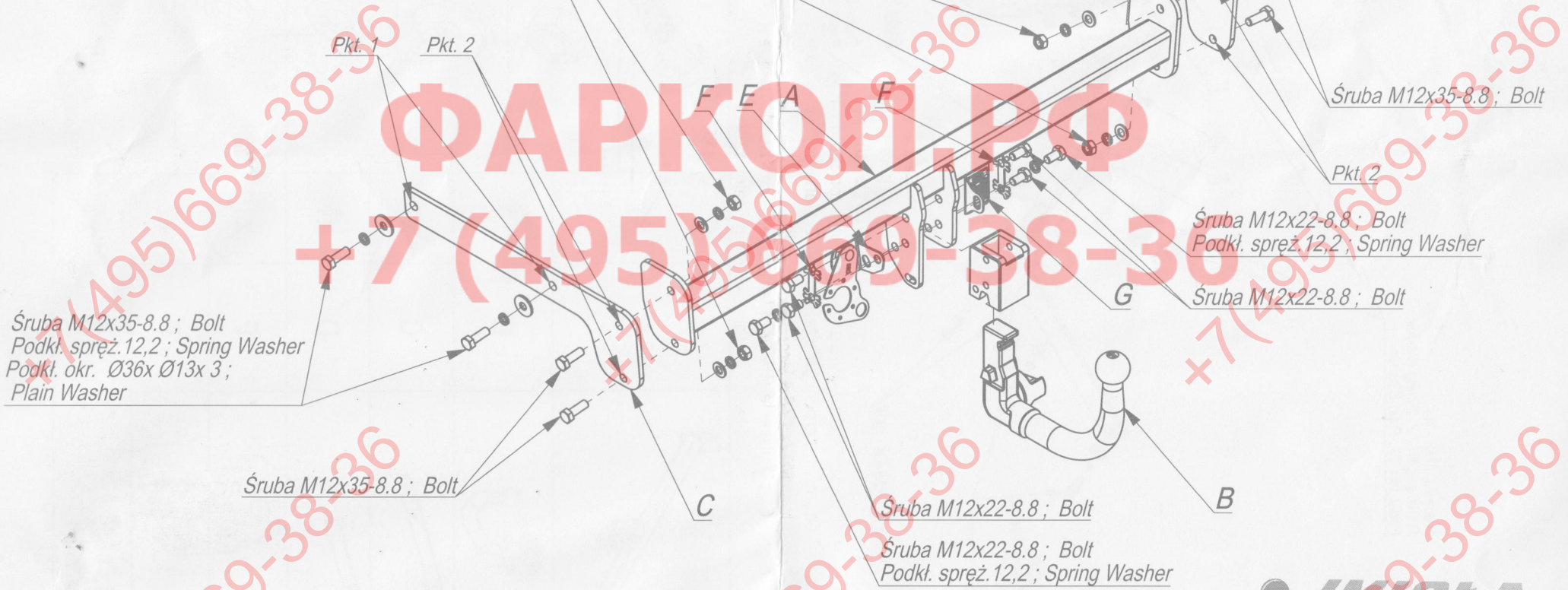

Śruba M12x35-8.8; Bolt  
Podkł. spręż. 12,2; Spring Washer  
Podkł. okr. Ø36x Ø13x 3;  
Plain Washer

Śruba M12x35-8.8; Bolt

Śruba M12x22-8.8; Bolt  
Podkł. spręż. 12,2; Spring Washer

Śruba M12x22-8.8; Bolt

Śruba M12x22-8.8; Bolt

Śruba M12x22-8.8; Bolt  
Podkł. spręż. 12,2; Spring Washer

Nr katalogowy Marka

T/A71

Toyota Corolla sedan, hybrid

Toyota Corolla Touring Sports, hybrid

od 2019 - >

od 2019 - >



96-111 Kowiesy, Chojnata 23 A  
tel. 48 46 831 73 31

+7(495)669-38-36

+7(495)669-38-36

+7(495)669-38-36

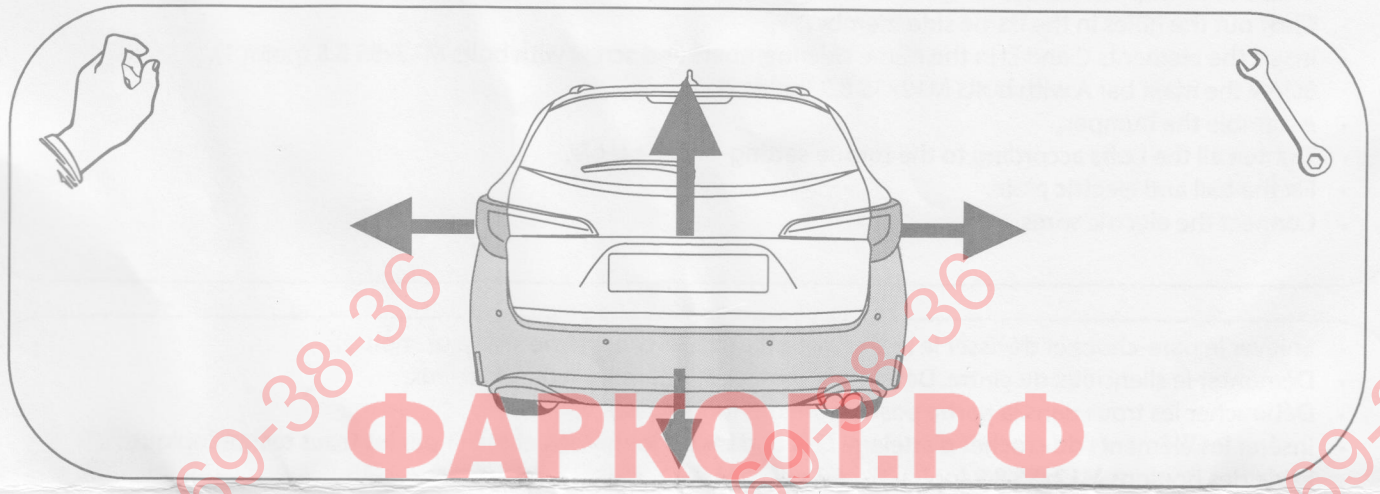
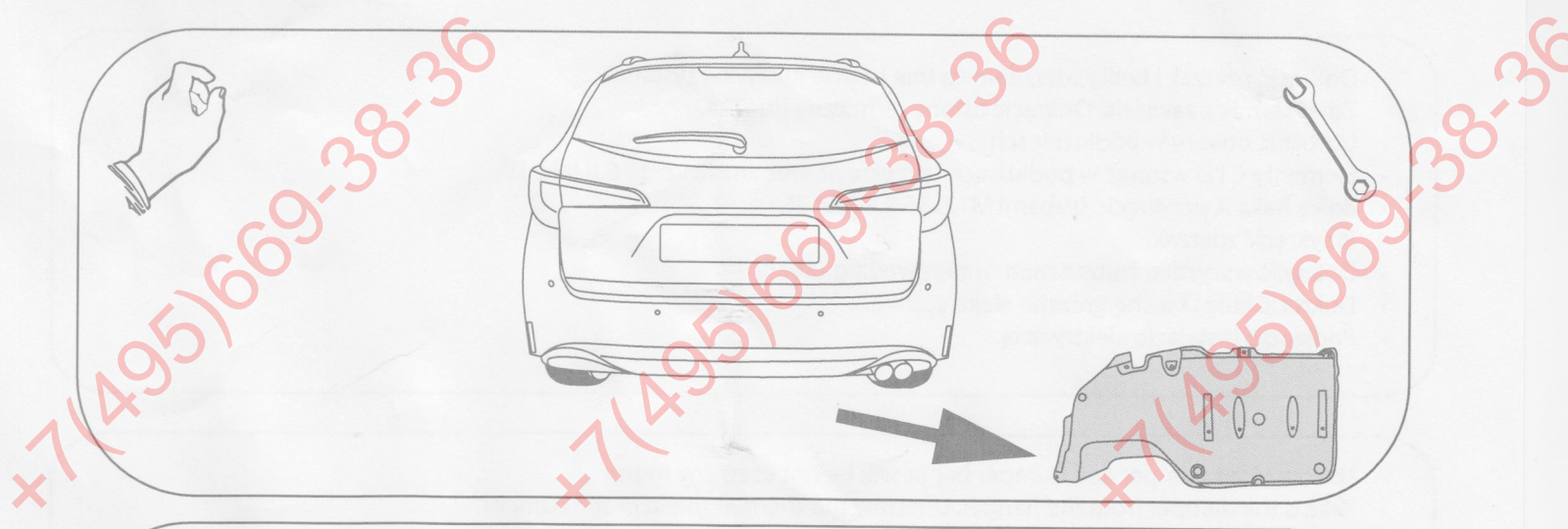

ФАРКОИ.РФ

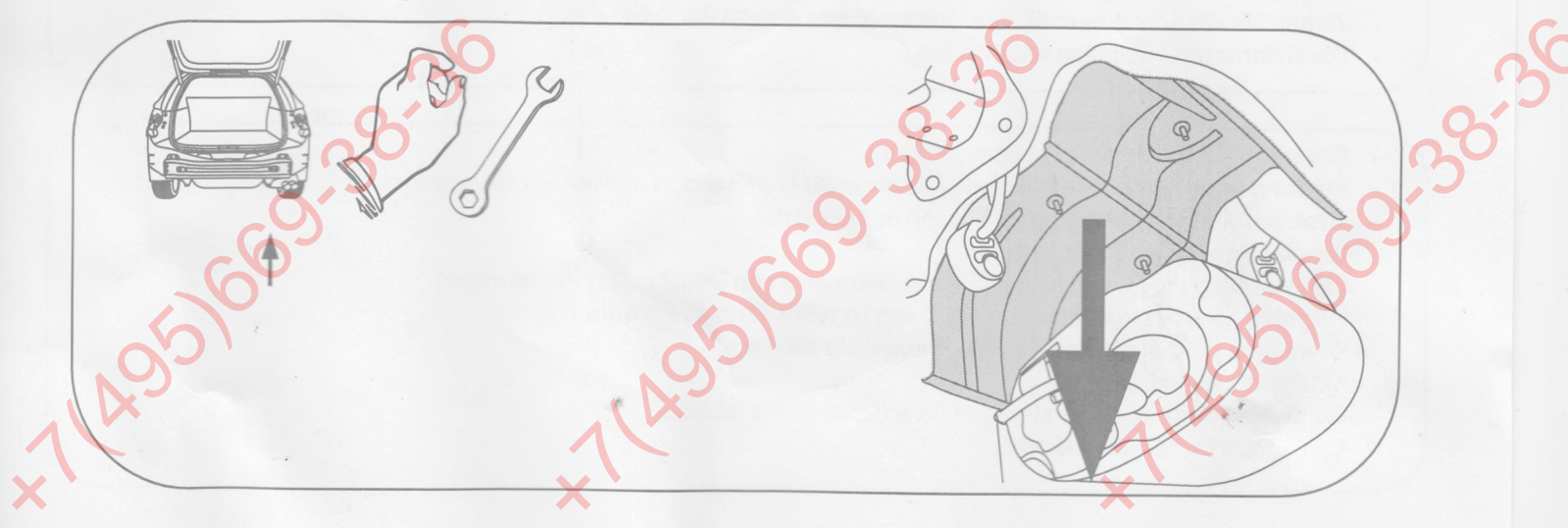
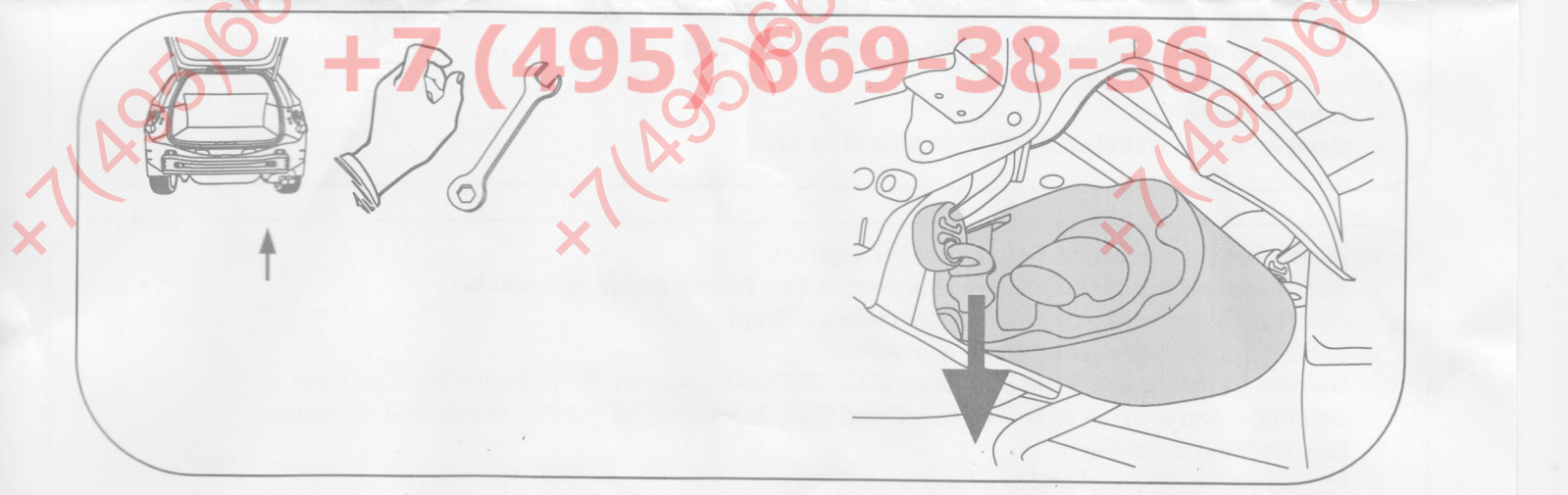

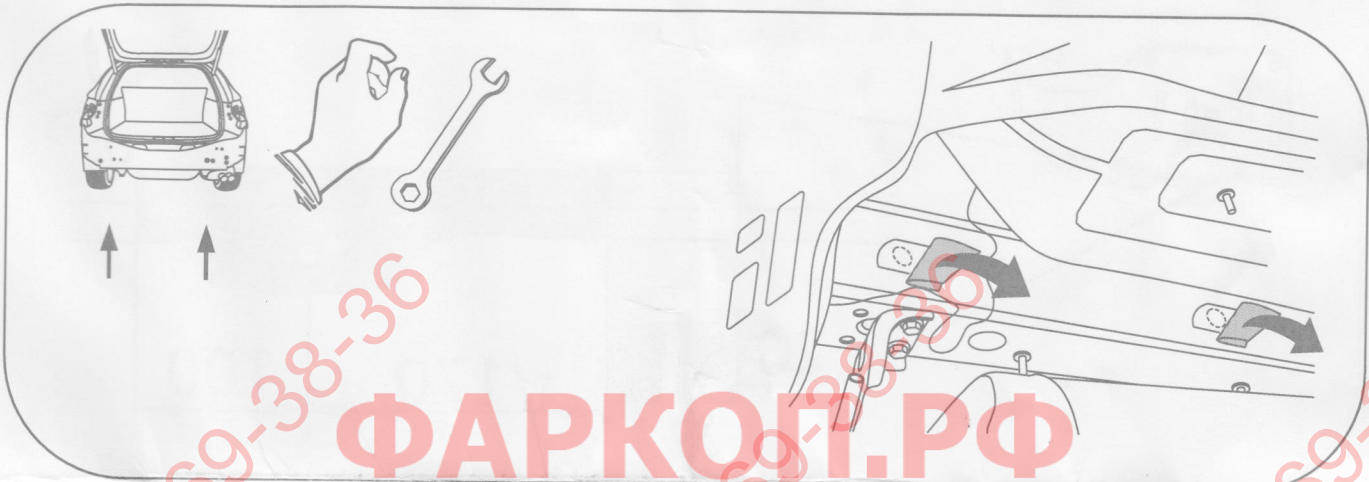
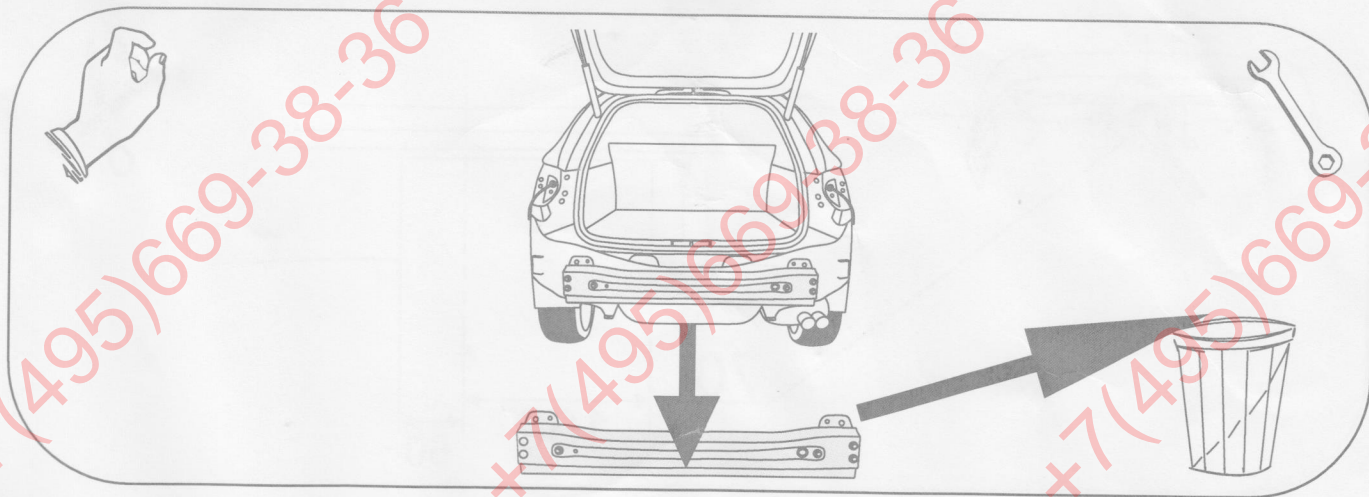

**ФАРКОП.РФ**

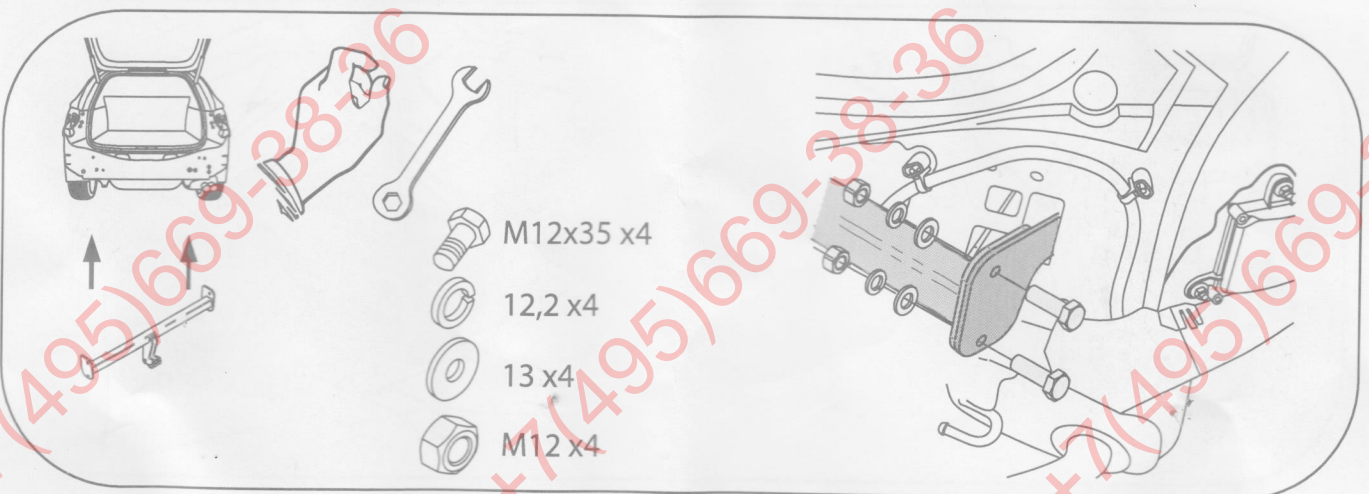
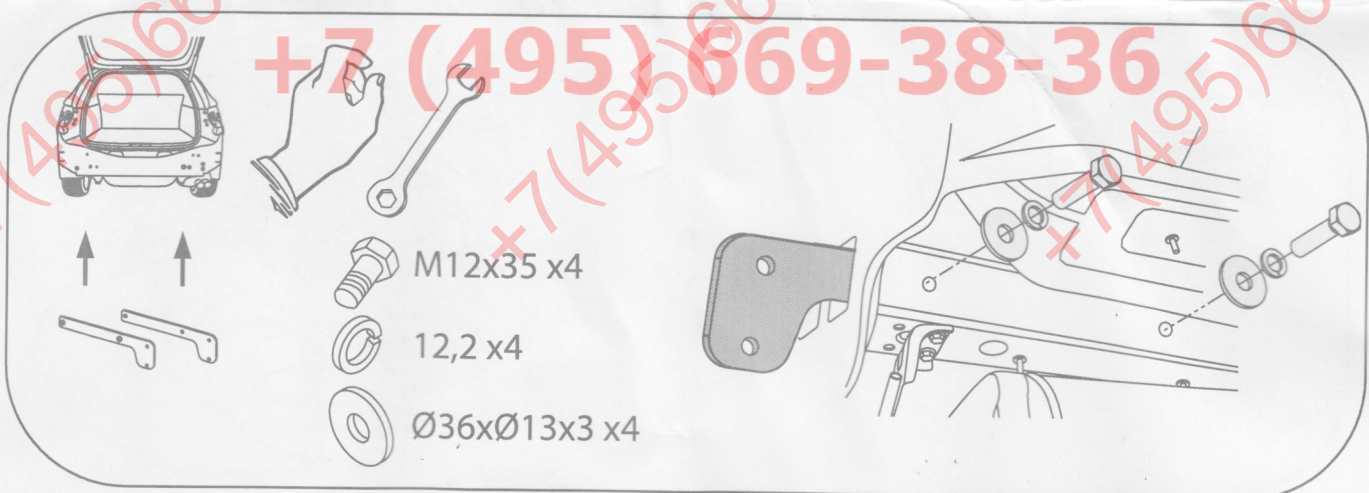

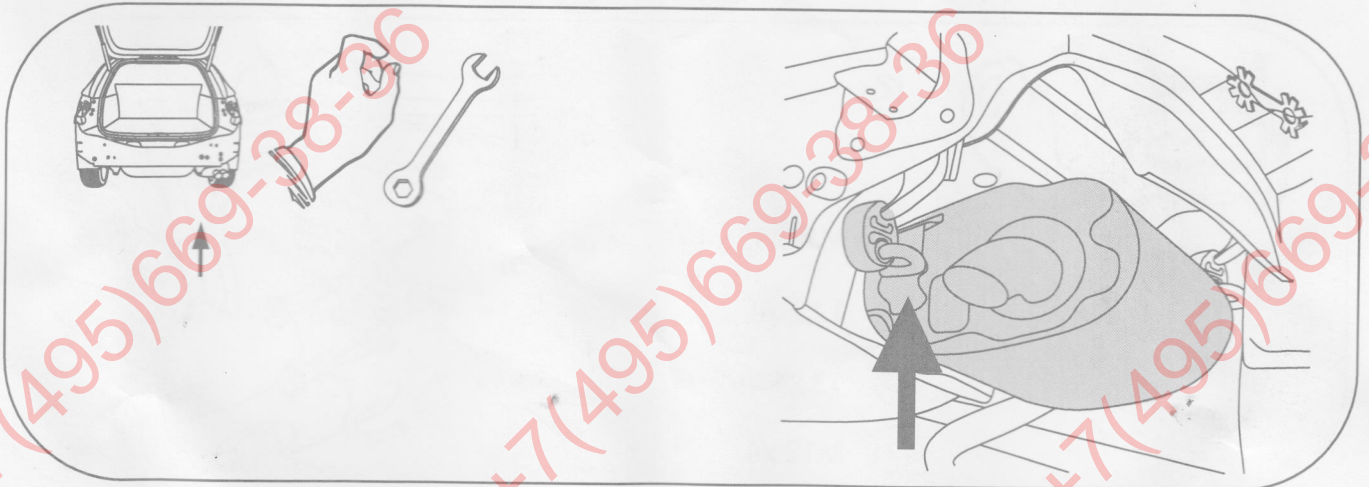
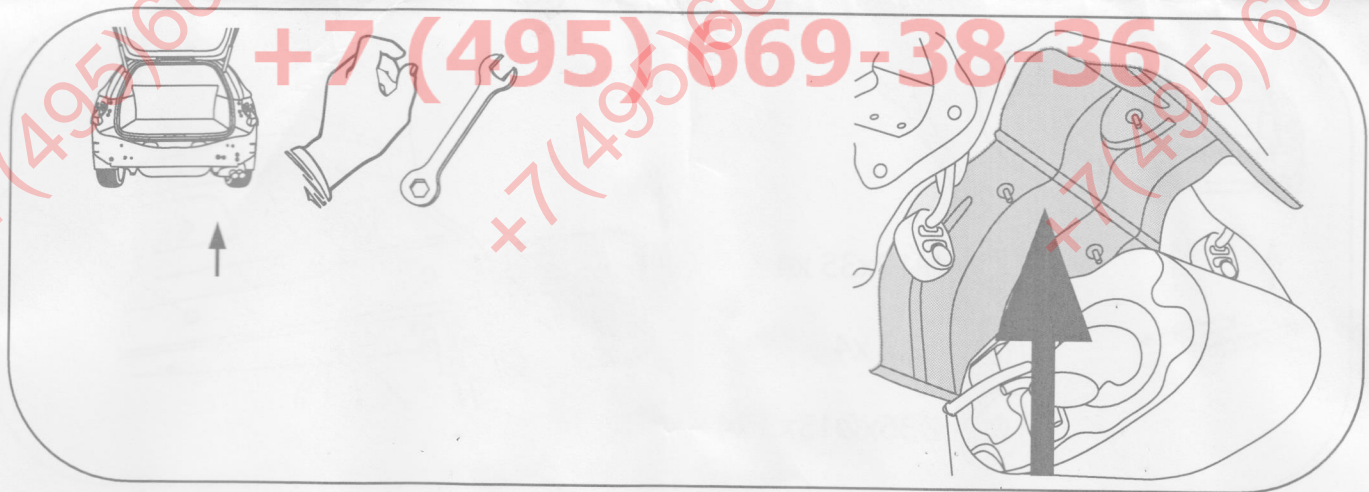
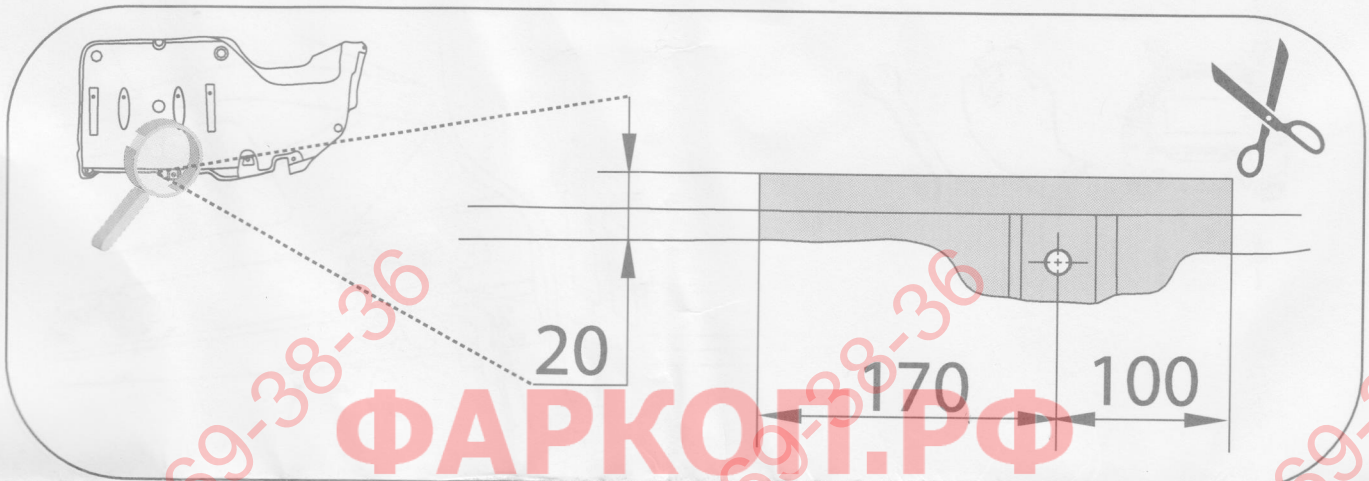
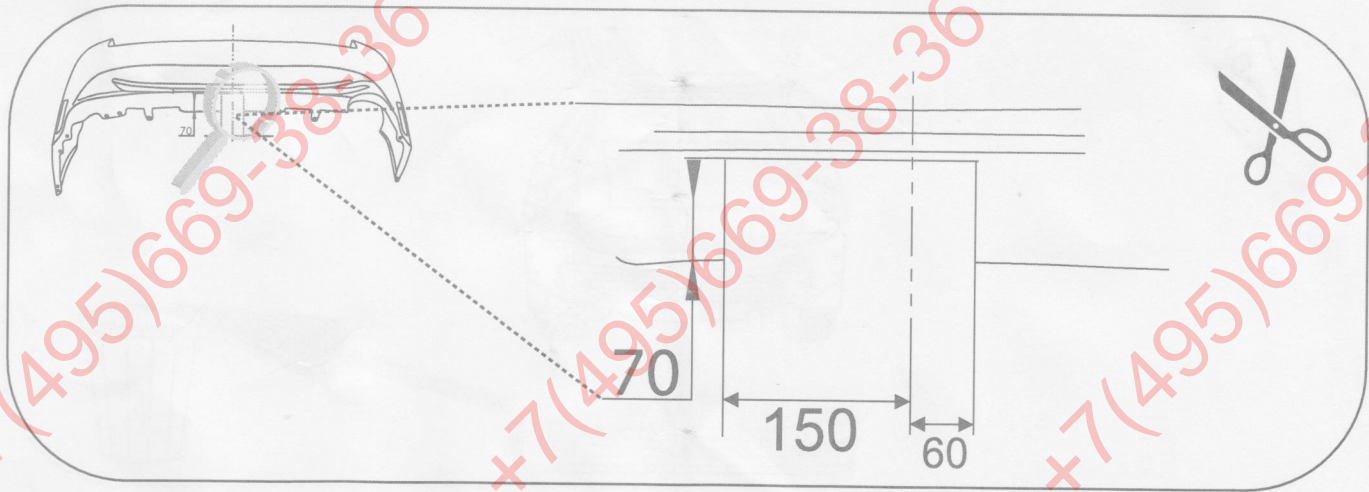

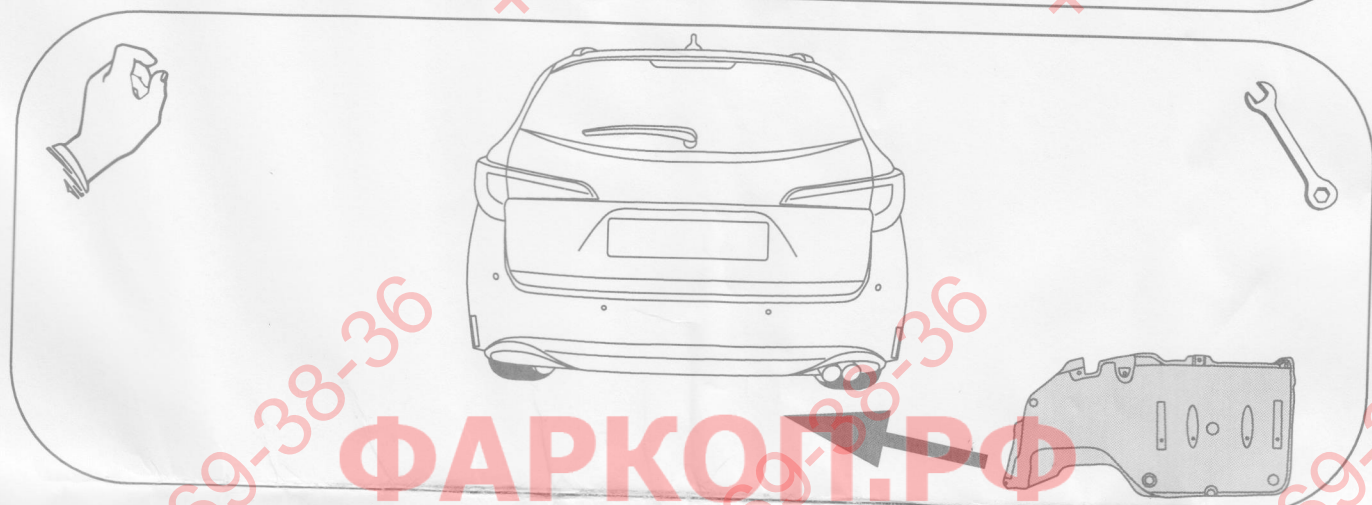
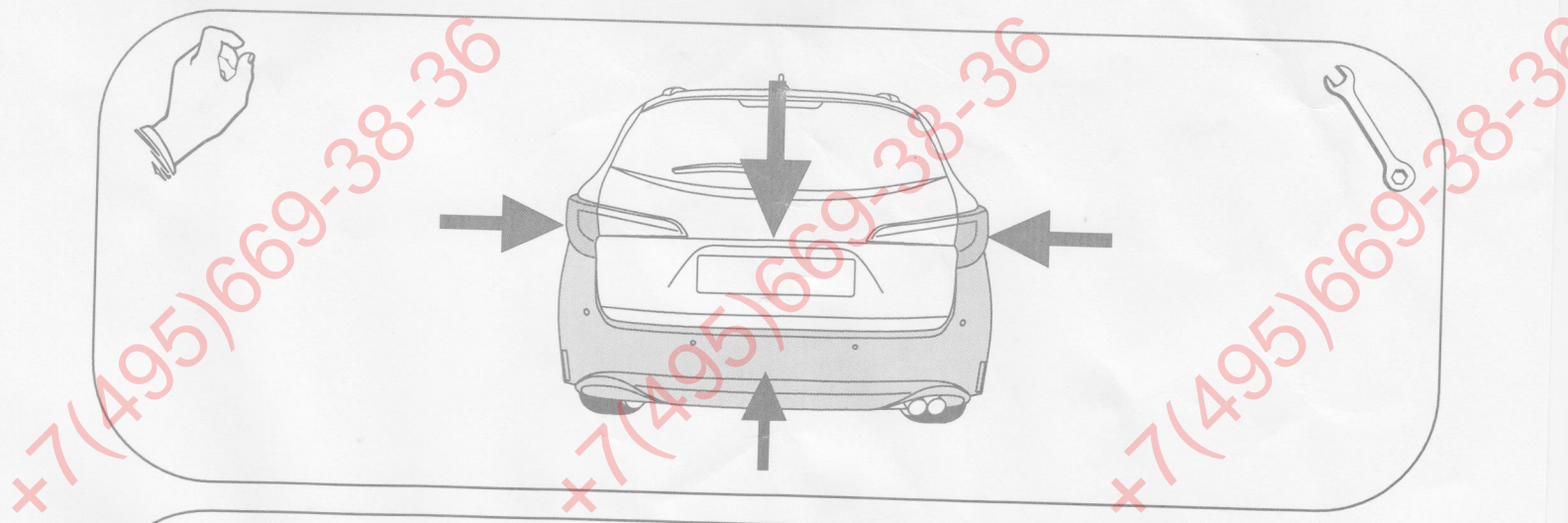



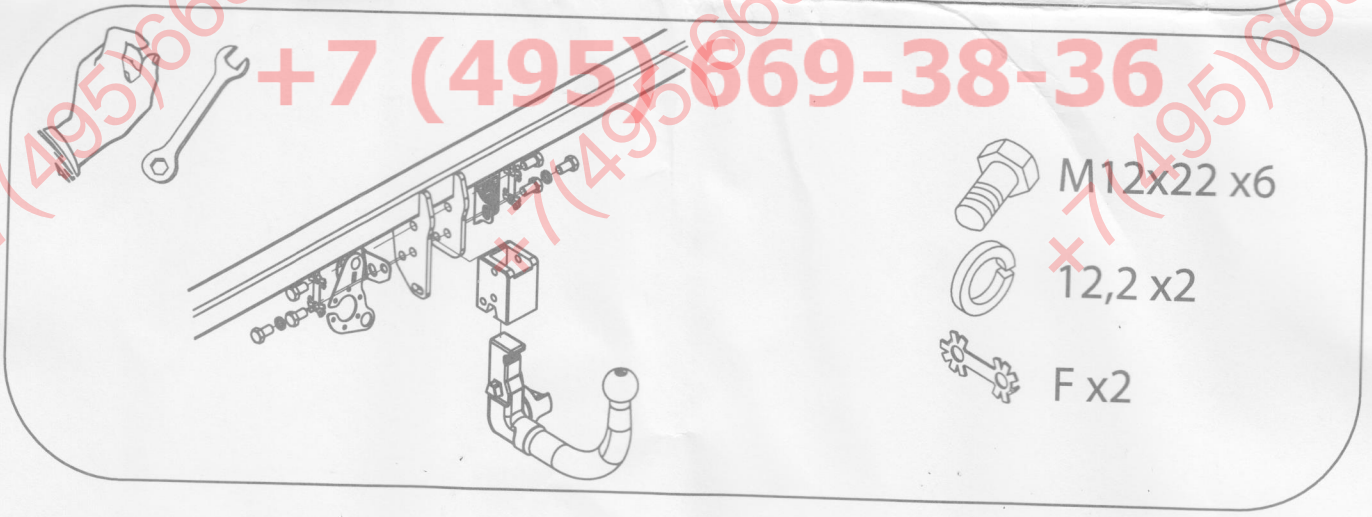

**ФАРКОП.РФ**

**+7 (495) 669-38-36**



-  M12x22 x6
-  12,2 x2
-  F x2

+7(495)669-38-36

+7(495)669-38-36

+7(495)669-38-36